



ADJUSTABLE SPRING POWER SURFACE APPLIED GRADE 1 CLOSER



# 44CI SERIES

HEAVY DUTY CAST IRON



**5 YEAR WARRANTY**

[Click Here For Info.](#)

## FEATURES

- Application for HIGH TRAFFIC Doors
- Cast Iron Body; Forged Steel Arm
- Double Heat Treated Steel Pinion
- All Weather Fluid
- Non-Handed
- Non-Sized Adjustable 1 Through 6; Standard with Back Check
- Universal Application for Regular Arm, Top Jamb, or Parallel Arm Mounting
- Standard Plastic Cover - Non Handed
- Hold-open arms are adjustable for holding from 85° to 180°.
- 5 YEAR WARRANTY



## OPTIONS AVAILABLE

- Metal Cover
- Heavy Duty Arm (EDA)
- Hold-Open arm
- Stop Only Arm
- Friction Hold Open Arm

## FINISHES

- AL - Aluminum
- DU - Storefront Bronze

**5 YEAR WARRANTY**

(Other finishes available by Special Order)

## TECHNICAL DIMENSIONS

Description	Dimensions
A. Length of Closer Body (With Cover)	12-1/4"
B. Horizontal Mounting Holes	SEE DRAWING
C. Vertical Mounting Holes	2-1/4"
D. Overall Height	4-7/8"
E. Top of Door to Bottom of Closer	3-11/16"
F. Closer Body Height	3-1/2"
G. Projection from Door	2-1/4"

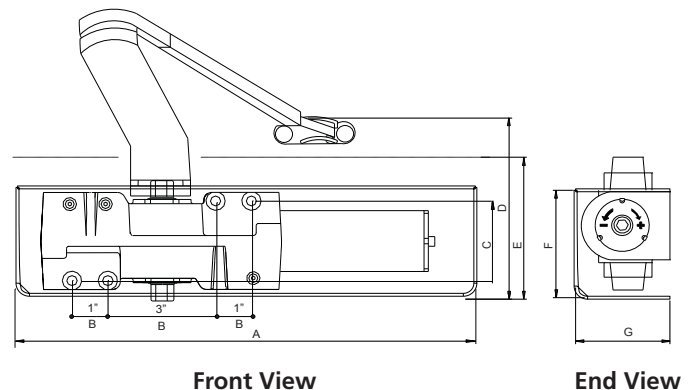

Front View

End View

**International Door Closers, Inc.**

COPYRIGHT 2021 INTERNATIONAL DOOR CLOSERS, INC

**West: 800-544-4422 • East: 800-225-6737**

**www.intldoorclosers.com**

## INSTALLATION TYPES

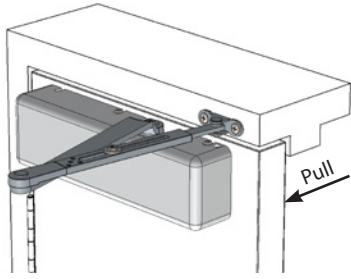

**Regular Arm (Pull Side)**  
Permits 120° maximum opening

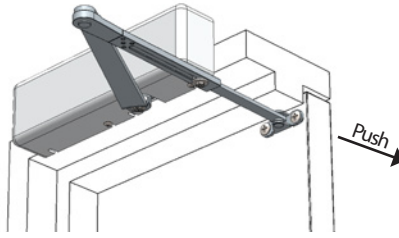



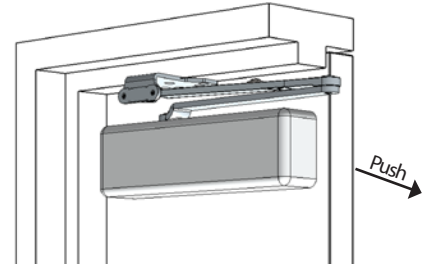





**Top Jamb (Push Side)**  
Permits 120° maximum opening



**Parallel Arm (Push Side)**  
Permits 180° maximum opening

## PARTS AND ACCESSORIES

## PART NO.

	Plastic Dress Cover	DC-44
	Metal Dress Cover (special order)	DC-44M
	Complete Arm Assembly	44-2021
	Cushion - Hold-open arm - Mechanical Turn Type	44-2022
	Cushion Stop Arm	44-2023
	Friction Hold Open Arm	44-2024
	Heavy Duty Arm (EDA)	44-2026
	Parallel Bracket	425
	Drop Plate for Pull Side installation when top Door Rail is less than 3-3/4". Requires a 2" minimum height Door Rail.	44-18
	Drop Plate for Top Jamb installation when ceiling is flush to top of Header. Requires a minimum 1-3/4" header height.	44-18G
	Drop Plate for Top Jamb installation on Door Headers less than 3-1/2" in height.	44-18J
	Drop Plate for Parallel Arm installation on Door Rails less than 5-1/2" (measured down from the door stop). Requires a 2" minimum height Door Rail.	44-18PA

SPECIFY FINISH:  
• AL - Aluminum  
• DU - Storefront Bronze